

Cleaning Technology · Municipal Technology

**Hako**



AGR quality label: Awarded for the overall machine concept, i.e. the machine as a workplace, the chassis and the quick-change system. [www.agr-ev.de](http://www.agr-ev.de)

## **Citymaster 1650**

***More working comfort in all conditions***

*Multifunctional city cleaning machine in the 3.5 t class*



*„A powerful and efficient  
solution with extra benefits  
for the driver!“*

**CITYMASTER 1650**

### *For the operator*

*More driving- and operating comfort: AGR-certified for the machine's award-winning, ergonomic design of the driver's workplace and the back-friendly quick-change system.*

## The premium solution for highest demands

### *For the environment*

*Reduced fuel consumption and fewer emissions: intelligent drives, low-emission engine with a particle filter and EUnited-certified dust-control system.*

### *For excellent results*

*Highest levels of flexibility and efficiency: multifunctional machine with a wide range of attachments and superstructures for every seasonal requirement.*

## The **Citymaster 1650** moves people

*This compact, professional city cleaning machine with add-on benefits is setting new standards in the 3.5 t class: for example with articulated steering and permanent all-wheel drive, or hydraulic attachment drives and a full-suspension chassis.*



Scan the QR code  
and experience  
the machine's  
many benefits!



## Ergonomic in every detail

The Citymaster 1650 offers an extensive range of innovative features providing more working comfort, safety and efficiency – whether used exclusively as a compact road sweeper or as a versatile implement carrier for all-season municipal application. After all, even the best machine is only as good and efficient as its operator. The Citymaster 1650 has therefore been designed as an ergonomic, mobile workplace that protects the operator's health, makes his daily work routine easier – and thus increases his efficiency at work.

### Always a good feeling

On first entering the spacious cabin, one thing becomes obvious at first glance: This workplace has been designed to benefit the machine operator. Both the steering wheel – adjustable for height and tilt – and the comfort seat allow individual adjustments.

## Designed to benefit the operator

The machine is controlled through the operating panel integrated in the armrest, including additional functional elements such as the one-button operating system providing automated functional processes for machines with complex configurations. The USB connection at the steering column allows the driver to keep his mobile phone charged, so that he can always be contacted in an emergency. Both the heating- and ventilation systems as well as the air conditioning ensure comfortable working in every season. And when the job is done, the cabin can be exited on both sides.



### Superior, award-winning comfort

The ergonomic machine concept featuring an adjustable comfort seat, Hako's tool-free quick-change system and a full-suspension chassis makes the Citymaster 1650 a particularly comfortable workplace – tested and certified by AGR/Aktion Gesunder Rücken e. V. ([www.agr-ev.de](http://www.agr-ev.de)).





## Flexible, safe, future-oriented

Compact, manoeuvrable, high climbing ability: The Citymaster 1650 can work in all paved urban areas – without restrictions and at maximum payload. Thanks to the machine's slim design and high level of manoeuvrability, Hako's solution covers the performance range of a larger sweeper while allowing employment even in confined areas and on footpaths.

The Citymaster 1650 offers all the characteristics and benefits of a larger sweeper but can be driven by anyone holding a Class-B driving licence.



### Ready for use in all conditions

The sophisticated, full-suspension chassis enables effortless kerb-climbing and driving on poor roads and paths – without compromising on either the driver's comfort or safety.

# Clean ahead – with foresight and good vision

## Environmentally friendly

The machine's particularly low fine-dust-, particle- and noise emissions allow working in both inner-city and residential areas – even early in the morning or late at night.

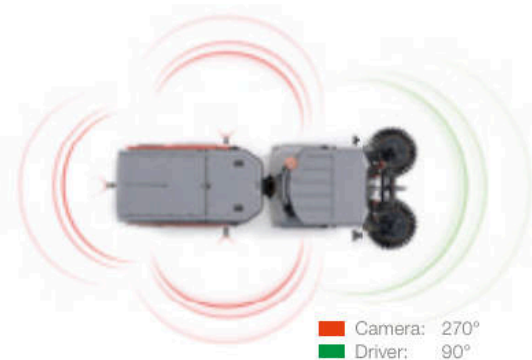
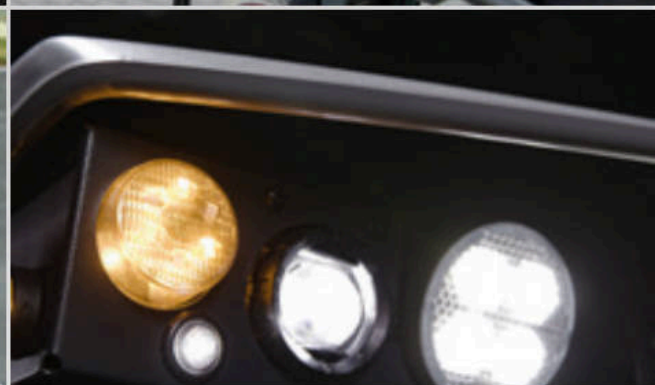
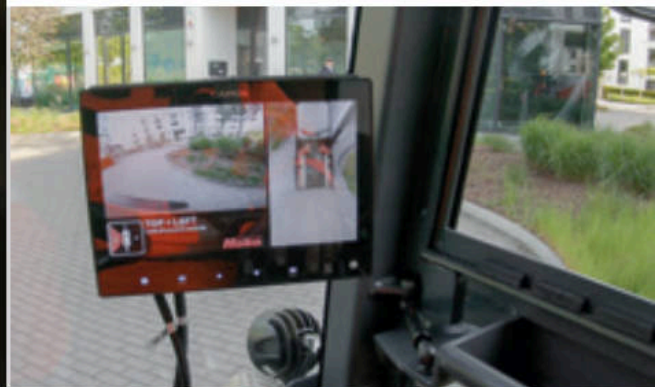

Everything at a glance: The fully glazed comfort cabin offers the driver an excellent view of his surroundings. The camera system extends the driver's field of vision by another 270° – and automatically provides a view to the side when turning.

## Keeping an eye on what's most important

Working in complex environments with heavy pedestrian traffic is a particularly challenging task for operators of Municipal Technology machines. Hako deals with this challenge by offering sophisticated safety concepts: for example camera assistance systems providing a 360° view even when the driver's field of vision is reduced by obstacles, or when reversing or turning. And thanks to the full LED lighting system, the driver always has a perfect view of his surroundings, even in poor light conditions – for safe working at any time and season.



## Multifunctional working in all seasons

The Citymaster 1650 has been designed for all-season application to provide maximum flexibility and economic efficiency. In addition to being used as a professional sweeper, this machine can easily and effortlessly be re-tooled for a wide range of different applications – thanks to the quick-change system allowing back-friendly and tool-free changing of attachments and superstructures and docking to the machine’s four interfaces. For example for:

- seasonal applications such as winter services
- various applications in the field of grounds- and road side greenery maintenance
- intensive yet gentle wet cleaning of heavily soiled areas



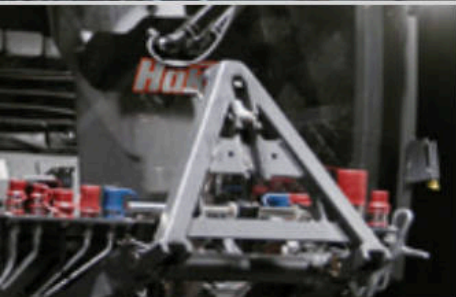

Quickly ready for use:  
thanks to the quick-coupling  
triangle providing easy changing  
of attachments.



Sweeping



Wet cleaning



Green area  
maintenance



Winter service



Transport



Sweeping  
2 brooms



Scrubbing



Mowing +  
discharge



Snow blade



Tipper



Sweeping  
3 brooms



Sluicing



Mowing +  
collecting



Snow plough



Lattice box



Weed broom



High pressure  
washer



Flail mower



Snow sweeper



Trailer



Dirt sweeper



Watering arm



Thermal weeding



Snow blower



Leaves collecting



Reflector post  
washing



Hedge trimmer



Spreader



Leaves blowing



Brine sprayer



### 365 days. Countless tasks. Only one machine!

Each season comes with its very own challenges for Municipal Technology equipment. Whether city cleaning, grounds maintenance or winter service – Hako meets every challenge by applying the principle of consistent multifunctionality: Thanks to the wide range of different attachments and superstructures available, you need only one machine to carry out a whole host of applications – 365 days a year; for efficient city cleaning, grounds maintenance or winter service tasks. We simply call it “One for all”. And our customers say: the right machine for every application.



## A clean performance on town squares, roads and paths

As a professional sweeper equipped with a 2- or 3-broom comfort sweeping system, the Citymaster 1650 not only provides perfect cleaning results: Our patented circulating water system offers maximum dust control to ensure clean exhaust air and lowest possible particle and fine dust emissions, which is a clear benefit for both the operator's health and the immediate surroundings.



### **Gentle yet effective cleaning – when sweeping alone is not enough!**

Equipped with Hako's CityCleaner attachment scrub deck, the Citymaster 1650 is ideal for carrying out intensive wet cleaning tasks. Perfectly suited for almost all types of surfaces. Goes easy on pavements and joints. And the circulating water system with efficient filters ensures optimal cleaning results.

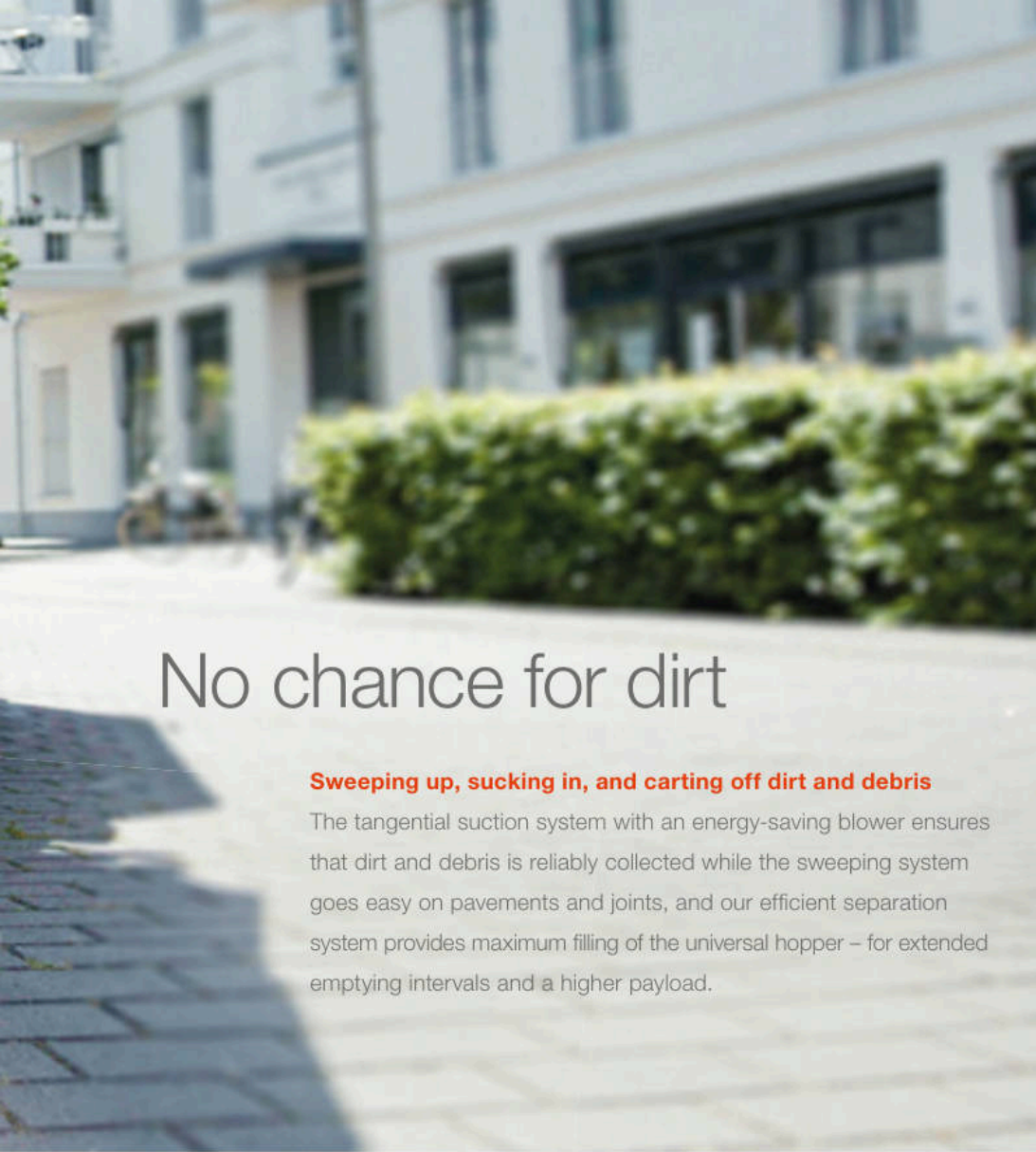

# No chance for dirt

## Sweeping up, sucking in, and carting off dirt and debris

The tangential suction system with an energy-saving blower ensures that dirt and debris is reliably collected while the sweeping system goes easy on pavements and joints, and our efficient separation system provides maximum filling of the universal hopper – for extended emptying intervals and a higher payload.



E-United:  
Highest award for  
lowest possible  
fine dust emissions.



Gets in almost every corner:  
The steering system with articulated joint ensures excellent manoeuvrability – even when sweeping in reverse gear.

Weed control without chemicals:  
The weed broom provides mechanical removal and collection of weeds.

## Perfect results on all levels

To ensure optimal cleaning results, the brooms with hydraulic broom-head-adjustment system can be adapted to different types of gutters. The pre-sweep broom can also be used for second-level cleaning of footpaths or even traffic islands. And what's particularly practical: Thanks to the double-joint broom arm, there is no need to adjust the unit when changing from sweeping one side of the road to the other.





## Powerful and efficient in every season



When the Citymaster 1650 is underutilised in its function as a professional sweeper due to seasonal weather conditions, the machine can be used to carry out other tasks such as grounds maintenance or winter services – which makes the Citymaster 1650 the most efficient solution for every municipal application.



### Highly flexible in grounds maintenance

From mowing grass and cutting back roadside greenery to maintaining sports grounds and public parks: The Citymaster 1650 is ideally suited for every green-area maintenance task. Thanks to its universal hopper, the machine can also be used to mow and collect grass; and the central suction system allows safe maintenance of roadside greenery in flowing traffic, even working close to kerbs on both sides of the road. In addition, large rotary mowers – designed as either rear-discharge or mulch mowers – as well as different flail mowers are available for mowing large areas.



### Perfectly equipped to fight ice and snow

For more safety in cities and municipalities: The Citymaster 1650 can be equipped with a wide range of different snow ploughs and universal front sweepers to clear roads, paths and public places from ice and snow. Powerful rotary snow blowers can easily deal with even large amounts of snow. Equipped with a loading bed and a rear-attachment gritter or with a top-mounted silo gritter, the Citymaster fights black ice reliably and effectively.



# Optimising resources: Hako-Fleet-Management

The larger the number of machines in your fleet, the more important it is to have a good overview of all relevant key data. With Hako Fleet Management, Hako offers fleet managers a digital solution for keeping their fleet of machines reliably under control – accessible around the clock and on all web-based systems. To ensure optimised operation of your fleet, Hako-Fleet-Management consists of four modules that can be individually combined with each other:



**view.X** supports economically efficient utilisation and management of your fleet. All evaluations are available online 24/7, and are easy to retrieve thanks to the tool's intuitive user interface.



**view.X.live** contains all data and information recorded by view.X. In addition, all operation-relevant data of your fleet of machines is transmitted "live" and then visually processed in the web portal. This information can be used as a performance record for clients.



**entry.X** is our optional electronic machine access authorisation system which enables fleet managers to set up access accounts for authorised users only.



**data.X** is an interface for authorised third-party suppliers of telemetric systems allowing local access to raw operating data directly at the machine.

# Technical data

Technical data basic unit Citymaster 1650		
<b>Engine and drive</b>	Engine	<ul style="list-style-type: none"> <li>• water-cooled 4-cylinder industrial diesel engine with 1,952 ccm</li> <li>• exhaust gas turbocharging + charge air cooling, particle filter, output 55 kW at 2,700 rpm</li> <li>• common-rail direct fuel injection, tank capacity 50 l</li> <li>• engine comes below the threshold value according to exhaust directive 2016 / 1628 / EC Stage V</li> </ul>
	Road approval	<ul style="list-style-type: none"> <li>• EU type approval basic unit as a tractor (LoF)</li> </ul>
	Drive	<ul style="list-style-type: none"> <li>• traction- and energy-efficient optimized hydrostatic drive with permanent all-wheel drive</li> <li>• drive control system with automatic load regulation in transport mode, 2-speed automatic transmission</li> <li>• 3-level fixed rpm in work travel mode (1,600 rpm [ECO] – 2,000 rpm [Standard] – 2,400 rpm [MAX])</li> </ul>
	Hydraulics	<ul style="list-style-type: none"> <li>• load-sensing high pressure hydraulics with variable power distribution for rotatory consumers</li> <li>• circuit 1 (front) 0-50/0-70 l/min @ 255 bar</li> <li>• circuit 2 (rear) 0-20/25/30 l/min @ 195 bar</li> <li>• 2 hydraulic circuits at the front, 1 hydraulic circuit at the back</li> </ul>
<b>Driving and working characteristics</b>	Speed	<ul style="list-style-type: none"> <li>• driving speed automotive 0 – 40 km/h</li> <li>• work travel hydrostatic 0 – 24 km/h</li> <li>• reverse 0 – 12 km/h</li> </ul>
	Steering and chassis	<ul style="list-style-type: none"> <li>• hydraulic 4-wheel chassis with articulated steering, steering angle 45°</li> <li>• robust articulated joint with maintenance-free PTFE-coated bearings</li> <li>• trailing-arm-guided, suspended front and rear axles, coil springs and hydraulic shock absorbers</li> <li>• stabilizer at the rear axle</li> </ul>
	Brake system	<ul style="list-style-type: none"> <li>• hydrostatic brake acting on all four wheels, disc brake at the front with load-dependent support via drive control acting on both axles</li> <li>• electrically activated multi-disc stop brake at the rear axle</li> </ul>
	Tyres	<ul style="list-style-type: none"> <li>• 225/70 R15C (M+S road tyres standard)</li> <li>• 255/65 R16C (M+S universal tyres § 35 StVO)</li> <li>• 320/55-15 (lawn tyres)</li> </ul>
	Cabin	<ul style="list-style-type: none"> <li>• 1-seater comfort cabin with comfort driver's seat and operating panel integrated in the armrest</li> <li>• central display showing all the machine's functions, adjustable steering column</li> <li>• hot-water heating and optional air conditioning</li> <li>• framed doors with sliding windows</li> <li>• folding exterior mirrors, adjustable from the inside</li> </ul>
	Load data	Dead weights
	Permissible values	total weight 3,500 kg, axle load 1,700/2,400 kg (front/rear)
<b>Dimensions</b>	H/W/L	basic unit: 1,970 mm x 1,210 x 3,830 mm (standard tyres, without tow bar) Sweeper: 1,970 mm x 1,210 x 4,510/5,170 mm (standard tyres 2B/3B)
	Wheelbase	1,600 mm
	Track width	975–1,055 mm
	Inner turning radius	1,290 mm

Form, colour and design of our products are subject to change in favour of further technical development.

Pictures may show optional equipment.

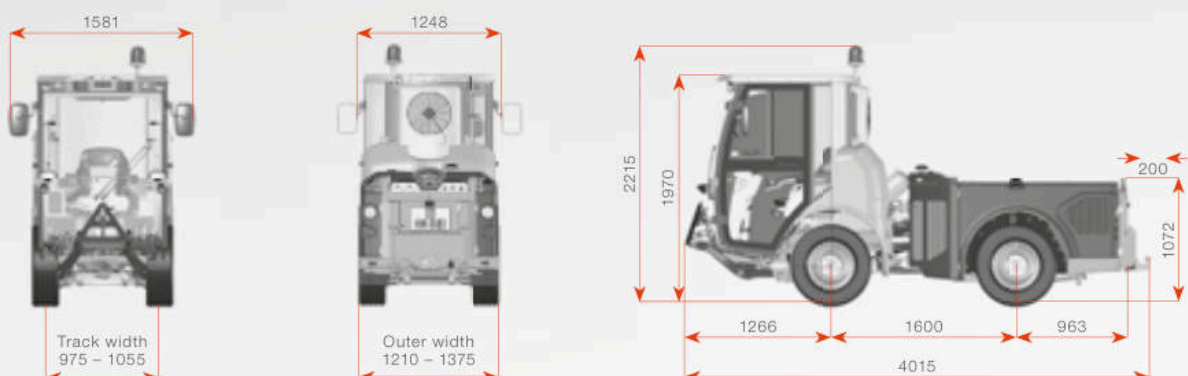



Cleanliness meets safety:  
Our machines meet even  
the highest standards.

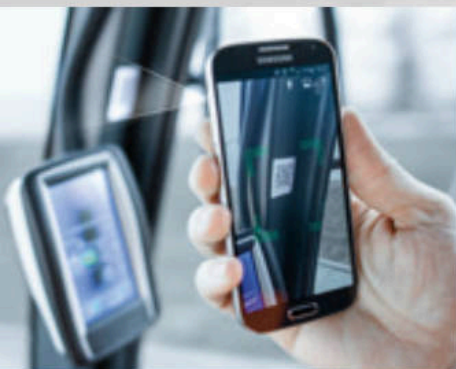

## Excellent services

### Full availability, full security

Permanent machine availability, minimal downtimes, and maximum economic efficiency: Thanks to both our close-knit sales & service network with 650 service technicians available around the clock all across Europe and our efficient spare part delivery service, plus our digital service solutions such as QR service codes attached to each of Hako's machines.

### Attractive financing alternatives

We offer you a complete package of efficient machines and excellent services at fixed, calculable costs over the entire service life of your machines, perfectly adapted to meet your individual requirements and maintain a maximum of flexibility.



Leasing options – perfectly adapted to meet individual customer requirements.



Rental contract ALL-IN-plus – financing, maintenance and insurance included!



Hire purchase – customised monthly payments in line with your liquidity.



Seasons – adapt your rental payments to your seasonal earnings.



Blue Competence is an initiative of VDMA (www.vdma.org). By engaging in this partnership, we are committed to comply with the twelve sustainability principles applied in the field of mechanical and system engineering (www.bluecompetence.net/about).

Hako Machines Ltd  
Eldon Close,  
Crick, Northampton  
NN6 7UD  
**01788 825600**  
**enquiries@hako.co.uk**  
**www.hako.co.uk**